

Created to help us be more sustainable, to simplify life and improve our habits

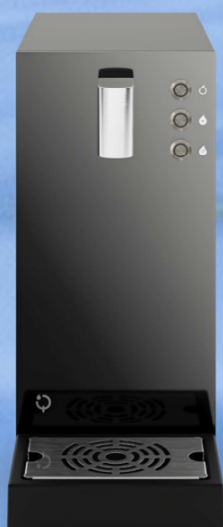

THE NEW WAY OF DRINKING WATER AT HOME OR IN THE OFFICE, WITHOUT PLASTIC BOTTLES

Q1 Top is the above-counter solution, with an elegant, silent and compact design. Ideal for serving microfiltered water, at room temperature and cold (Q1 Easy), and cold sparkling water (Q1 Bubble). It is available in black and white, with a front panel entirely made of tempered glass for an elegant design.

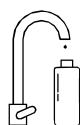

We are an innovative company that pays attention to sustainability. We address those who consider water a precious resource, which should not be wasted but enhanced.

Q1 EASY

MICROFILTERED WATER



Q1 BUBBL

MICROFILTERED WATER

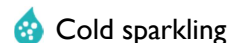

2 VERSIONS

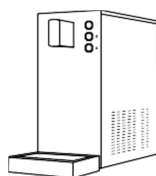

White
Precoated metal sheet

- Q1TE2A00
- Q1TB2A00

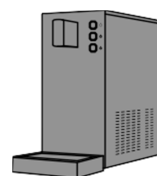

Black
Precoated metal Sheet

- Q1TE2B00
- Q1TB2B00



Sottobanco
Precoated meta sheet

DESIGN, FUNCTIONALITY E PERFORMANCE

Tempered glass front panel, backlit buttons and thin stainless steel headboard give it a unique and elegant design, perfect for the home and office environment. Thanks to its narrow shape and small dimensions, Q1 Top is the right solution for saving space, without sacrificing performance: the ice bank cooling system and cold carbonation keep the temperature and carbonation level of the water constant provided.

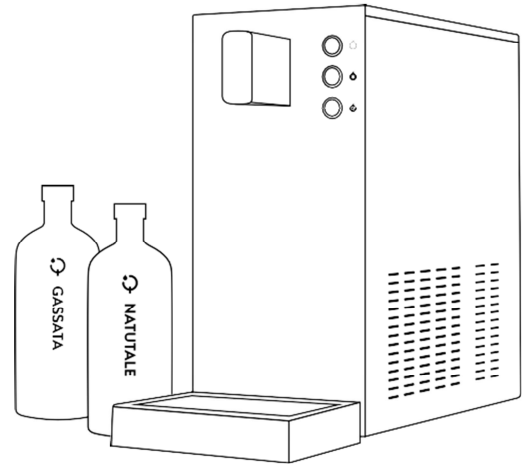

HYGIENE AND PEACE OF MIND

The internal components in direct contact with water are located in a protected space and are made entirely of stainless steel in order to guarantee maximum antibacterial action.



INSTALLATION AND SIMPLICITY

Q1 Top takes up very little space and is silent. Installation is simple and performance guaranteed.

A CUSTOMIZABLE SYSTEM THAT MEETS EVERY NEED

With Q1 Under you can choose the tap that best suits your needs



TAPS

Three different designs for 3 and 5 way sink mixers. For ambient, cold and cold sparkling filtered water Tap water mixer.

Dimensions	200 (L) x 844 (P) x 420 (H)
Technology	Ice bank
Ice bank	4,3 L capacity
Types of water	Ambient, chilled, sparkling, Not
Test conditions	20°C incoming water and 25°C room temperature
Performance	30 L per hour; 6 L continuously < 12°C
Boiler	0,5 L, 1200 W - temperature 98° C
Usage recommendation	Home, Small Office, bar: 1 - 20 people
Carbonator	Stainless steel carbonator , 0,5 L capacity
Carbonation Pump	Membrane pump
Refrigeration gas	R 290
Compressor	1/12 HP - 220/230 V 50 Hz
Thermostat	Mechanical
Condensation	Dynamic ventilation
Coils	6 mm stainless steel
Ø Water inlet	8 mm
Ø CO2 Inlet	6 mm
Ø Fill Ice bank	8 mm
Water inlet pressure	not over 3 bar - recommended reducer
CO2 inlet pressure	Ideal pressure: in between 3,5 - 4,5 bar
Finish	Housing skinplate, front glass or glazed aluminum
Power Supply	230 V - 50 Hz
Weight	21 Kg
Flow regulator	Included (into the unit)
Filtration	Not included
Water pressure reducers	Not included
CO2 pressure reducers	Not included
SHIPPING DETAIL	
Max qty for pallet	21 units
Pallet dimension	Epal 1200 x 800 mm

REAR VIEW

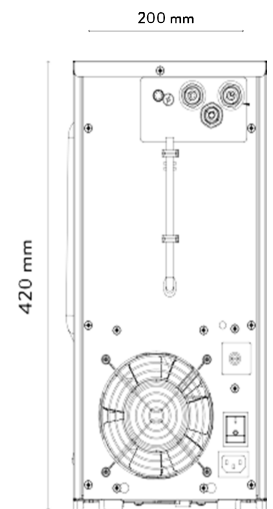

SIDE VIEW

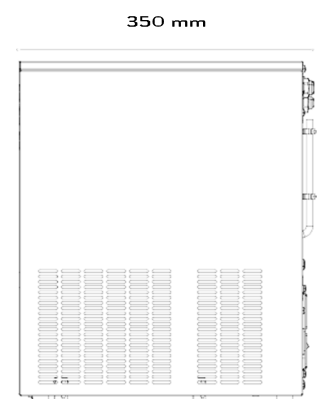

TAPS DIMENSIONS

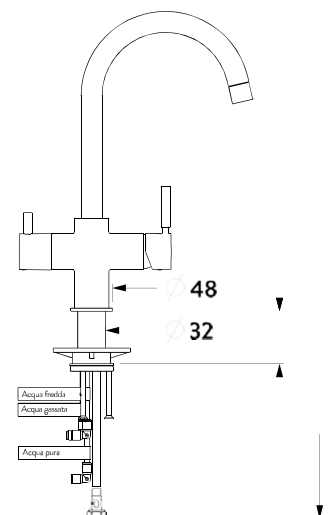

USEFUL FORUM Ø 35